

N-Channel Logic Level Enhancement Mode Field Effect Transistor

BSS138DW

FEATURES

- Low On-Resistance.
- Low Gate Threshold Voltage.
- Low Input Capacitance.
- Fast Switching Speed.
- Low Input/Output Leakage.

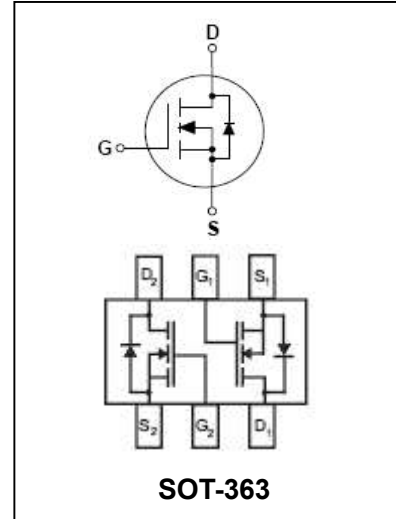

ORDERING INFORMATION

Type No.	Marking	Package Code
BSS138DW□	K38	SOT-363

□: none is for Lead Free package;

“G” is for Halogen Free package.

MAXIMUM RATING @ Ta=25°C unless otherwise specified

Symbol	Parameter	Value	Units
V _{DSS}	Drain-Source voltage	50	V
V _{DGR}	Drain-Gate voltage R _{GS} ≤ 20K Ω	50	V
V _{GSS}	Gate-Source Voltage	±20	V
I _D	Drain current -continuous	200	mA
P _D	Power Dissipation	200	mW
R _{θJA}	Thermal Resistance, Junction-to-Ambient	417	°C/W
T _J , T _{stg}	Junction and Storage Temperature	-55 to +150	°C

N-Channel Logic Level Enhancement Mode Field Effect Transistor BSS138DW

ELECTRICAL CHARACTERISTICS @ Ta=25°C unless otherwise specified

Parameter	Symbol	Test conditions	MIN	TYP	MAX	UNIT
Gate leakage current	I_{GSS}	$V_{GS}=\pm 20V, V_{DS}=0V$			± 1	μA
Drain-Source Breakdown Voltage	$V_{(BR)DSS}$	$V_{GS}=0V, I_D=250\mu A$	50	75		V
Gate Threshold Voltage	$V_{GS(th)}$	$V_{DS}=V_{GS}, I_D=250\mu A$	0.5	1.2	1.6	V
Zero Gate Voltage Drain Current	I_{DSS}	$V_{DS}=50V, V_{GS}=0V$			0.5	μA
Drain-source on-state resistance	$R_{DS(on)}$	$I_D=0.22A, V_{GS}=10V$		1.4	3.5	Ω
Forward transfer admittance	g_{fs}	$V_{DS}=25V, I_D=0.2A, f=1MHz$	100			mS
Input capacitance	C_{iss}	$V_{DS}=10V, V_{GS}=0V, f=1.0MHz$			50	pF
Output capacitance	C_{oss}				25	
Reverse transfer capacitance	C_{rss}				8	
Turn-On Delay Time	$t_{D(ON)}$	$V_{DD}=30V, I_D=0.2A,$ $R_{GEN}=50\Omega$			20	ns
Turn-Off Delay Time	$t_{D(OFF)}$				20	ns

TYPICAL CHARACTERISTICS @ Ta=25°C unless otherwise specified

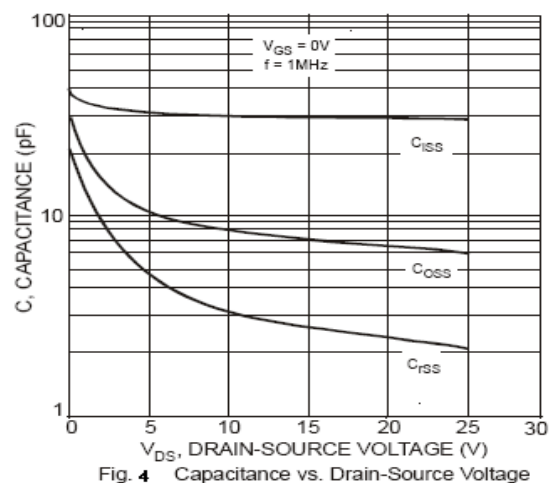
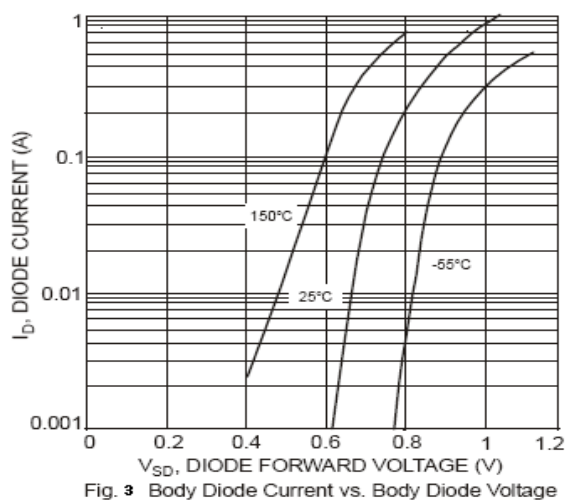
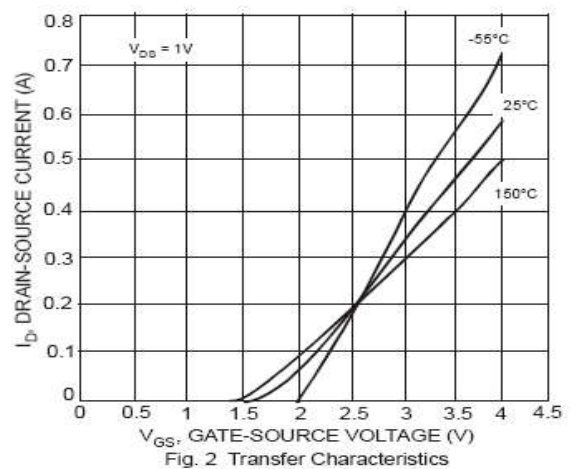
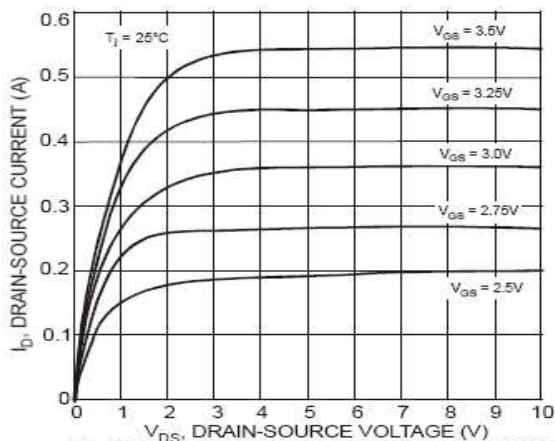

N-Channel Logic Level Enhancement Mode Field Effect Transistor

BSS138DW

PACKAGE OUTLINE

Plastic surface mounted package

SOT-363

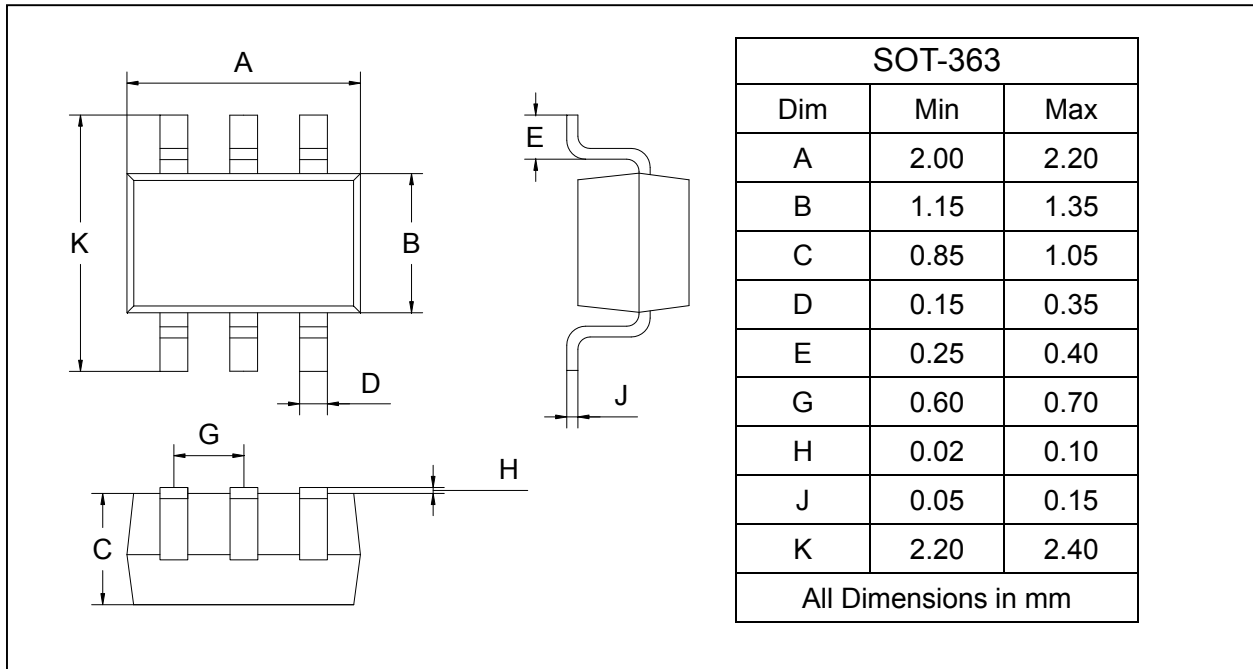

SOLDERING FOOTPRINT

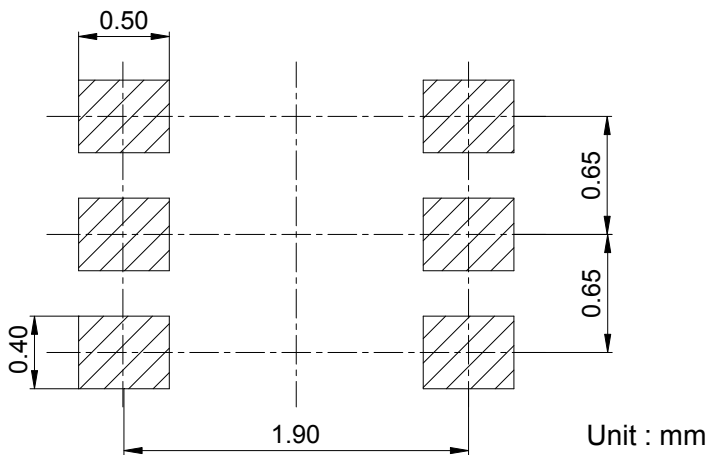

PACKAGE INFORMATION

Device	Package	Shipping
BSS138DW	SOT-363	3000/Tape&Reel